

Dental Unit

Instruction Manual



Please read this manual before operating

CE 0123

Contents

Part 1 Security Information	3
Part 2 Figures and Symbols	4
Part 3 Precautions	4
Part 4 Transport and Storage	5
Part 5 Introduction of Products	5
Part 6 Operation Conditions	6
Part 7 Basic Parameters.....	6
Part 8 Structural Diagram	7
Part 9 Installation of Products.....	8
Part 10 Testing	12
Part 11 Operation Instructions.....	12
1. Instructions for instrument tray button panel	12
2. Instructions for assistant tray.....	14
3. Instructions for water bottle	14
4. Instructions for foot controller	15
5. Instructions for water and air adjustment of handpiece	15
6. Instructions for LED operation lamp	16
7. Instructions of led film viewer	16
8. Instructions of three way syringes and saliva ejector	16
Part 12 Maintenance	17
Part 13 Troubleshooting	18
Part 14 Circuit Diagram	19
Part 15 Circuit Diagram of Patient Chair	19
Part 16 Water and Air Installation Diagram	20
Part 17 Schematic Diagram for Water and Air Routes	20

Part 1 Security Information

Please read this manual in order to use the dental unit correctly. If you have any special requirements, please contact our dealers.

1. In order to reduce the possibility of fire and electric shock, please do not place the device in a humid place, and please do not open the box. If you need to repair the machine, please find a professional service person.
2. If smoke or other abnormal status occurs to the unit, it may lead to fire, please immediately cut off the power supply, and contact local dealer or after-sales service department.
3. If water entering into the unit, it may cause electric leakage, please immediately disconnect the power, and contact local dealer or after-sales service department.
4. If any unknown fault occurs to the unit, please immediately disconnect the power, and contact local dealer.
5. Please don't detach or refitted the unit, otherwise some parts inside may be damaged or cause electric shock.
6. Keep the power cord from damage. If the power cord is damaged, immediately disconnect the power, and don't directly touch the power supply by hand. Please contact the local seller for replacing the damaged wires.
7. The unit is suitable for a.c 220V/110V working power, if it's used in other voltages, risk may occur
8. Please be attentive to the weather changes, and disconnect the power in case of lightning weather.
9. Don't touch the power plug with a wet hand, which may cause electric shock.
10. Please don't clean the unit with pesticides, alcohol, diluent and chemical liquids, which may result in surface peeling or decay.
11. Please don't restructure the unit. If there is any damage, no repair and warranty will be provided.

To users:

This product has passed the test and meets the requirements for use.



The unit is not equipped with a mercury separator, so the drainage system of this equipment cannot filter solid particulate debris or amalgam.

















We do not guarantee whether the discharged water will cause pollution. Please install a mercury separator on the drainage system of this equipment to avoid pollution of drainage

If you want to get detailed information, please contact the manufacturer.

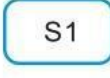
**Please record the product's serial number here
to be convenient for inquiry later!**

Part 2 . Figures and symbols

	Warning
	Type B apparatus: no electric connection part with patients
	Protect ground terminal

1		CHAIR UP	9		GARGLE WATER HEATING
2		CHAIR DN	10		PROG S3
3		BACK REST DN	11		Oral light
4		BACK REST UP	12		SPITTOON POSITION
5		GARGLE WATER SUPPLY	13		DOCTOR CHOOSE
6		PROG S1	14		SETTING
7		SPITTOON WASH	15		EMERGENC Y POSITION
8		PROG S2	16		RESETTING

Part 3 Precautions

- This product is only used for diagnosis, treatment and surgery in stomatology!
- Only use the fuses and accessories approved by our company!
- This product contains electro-mechanical moving parts, please make sure that no objects are touched within the working movement range!
- When not using this product, please lower the patient chair to the lowest position, and disconnect the water, air and power!
- Before using the patient chair, please make sure the pillow is locked!

-
- Do not use this product in environments with high temperature, high humidity, vibration, flammability, and imbalance!
 - The patient chair of this product belongs to intermittent operation equipment, and the continuous movement time should not exceed 1 minute!
 - Please refer to its instruction manual before using the handpiece!
 - Please refer to the instruction manual of the light curing and scaler!
 - Before using the water heater, the water source must be connected to prevent the water heater from burning and causing a short circuit!
 - When the equipment needs to be repaired or maintained, please contact the professional maintenance personnel. Before repairing, the water, air and power must be disconnected!
 - When not using the device for a long time, be sure to disconnect the water, air and power!
 - It is recommended to use the dental unit for a period of five years. Exceeding the period may lead to aging of pipelines, failure of function, and even accidents. Please contact a qualified medical device recycling unit to promptly eliminate or replace new device.

Part 4 Transport and Storage

1. Transport conditions: upward, handle with care, moisture proof.
2. Transport environment: temperature 5~40°C , relative humidity< 80%.
3. Wooden box transport or storage, shall not stack for more than two boxes.

Part 5 Introduction of Product

Spec.:	Dental Unit
Safety type:	Class II
Protection type:	Type B
Power type:	Single phase, three cores, power grid supply
Voltage:	a.c.220V; a.c.110V
Frequency:	50Hz; 60Hz
Input power:	320VA

※This product has application part, no signal input or output portion, belongs to a non-movable apparatus.

This unit is a kind of dental equipment specially produced and provided to qualified personnel in the clinical practice of dentistry and related operation steps.

It is composed of a set of interrelated dental equipment and instrument components for diagnosis,treatment and For surgery.

This product is mainly composed of dental patient chair, oral light, instrument tray, three way syringes, mouthwash dispensing device, saliva suction device, spittoon, led film viewer and foot switch.

Part 6 Operation Conditions

To ensure the normal use of the unit, the input water, air, electricity and working environmental parameters are as follows:

1. Air source: air pressure 0.6MPa ~0.8Mpa, flow >50L/ min, oil free
2. Water source: water pressure 0.20MPa ~ 0.40MPa, flow > 10L/ min , hardness <25 degrees
3. Power supply: a.c.220V/50Hz 10A
4. Environment: temperature 5~40°C, relative humidity 20%-80%

Part 7 Basic Parameters

- High-speed air turbine hand-piece no-load speed (pressure 0.22Mpa) $\geq 35 \times 10^4$ r/min
- Low-speed air motor hand-piece no-load speed (pressure 0.30Mpa) $\geq 18 \times 10^3$ r/min
- Oral cold-light lamp illumination weak light ≥ 8000 lx, bright light ≥ 15000 lx
- Film viewing lamp illuminance ≥ 2000 lx
- Dental patient chair's loading capacity ≥ 1323 N (135 Kg)
- Tool tray loading capacity ≤ 5 Kg
- Max. seat cushion height from ground ≥ 700 mm
- Min. seat cushion height from ground ≤ 500 mm
- Scope of backrest tilt: $105^\circ \sim 170^\circ$
- Scope of head frame stretch 120mm
- Max. seat cushion tilt angle $\geq 12^\circ$
- Temperature of constant-temp. water heater $40^\circ\text{C} \pm 5^\circ\text{C}$
- Work space Length ≥ 4000 mm/ width = 2600mm/ height ≥ 2000 mm

Part 8 Structural Diagram

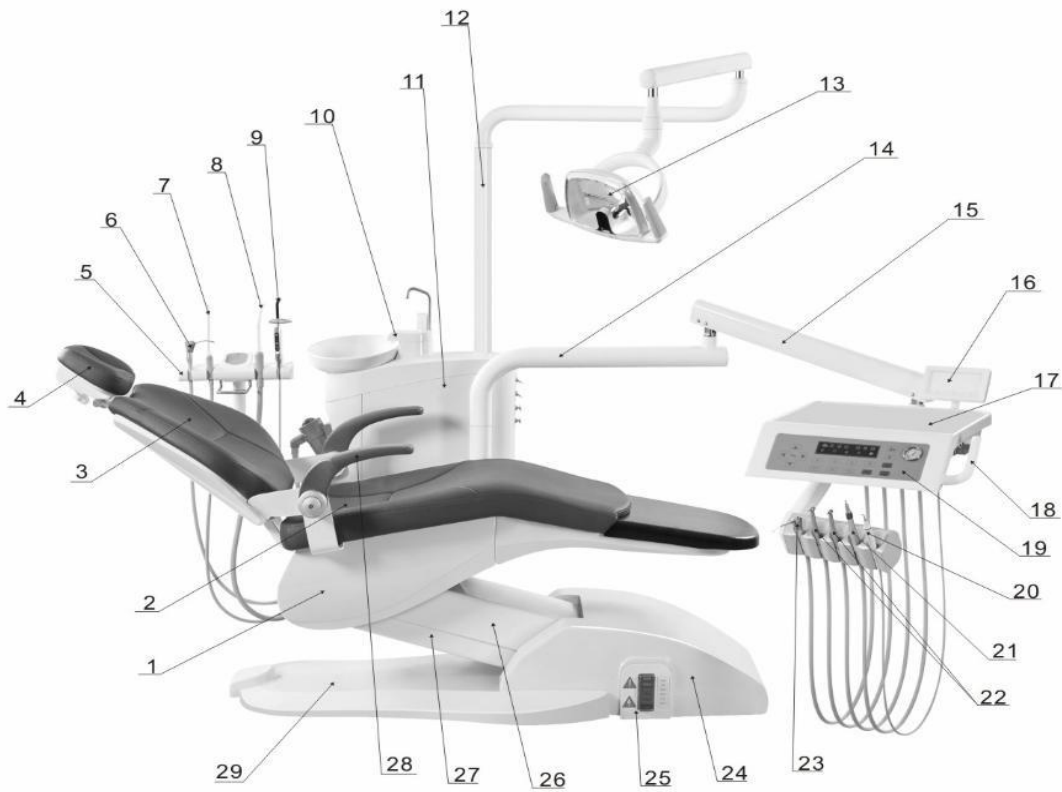

1. Cover	2. Seat cushion	3. Backrest	4. Headrest
5. Assistant tray	6. three way syringes (hot)	7. Weak suction	8. Strong suction
9. Curing light	10. Spittoon	11. Unit box	12. Column
13. LED sensor lamp	14. Front rotary arm	15. Back rotary arm	16. LED film viewer
17. Doctor tray	18. handle	19. Control panel	20. Ultrasonic scaler
21. Low speed handpiece	22. High speed handpiece	23. three way syringe (cold)	24. Front cover
25. transformer fuses	26. Upper shell	27. Lower shell	28. Arm rest
29. Bottom housing			

Part 9 Installation of Products

I. Installation Space

1. Environmental requirements

To ensure the normal operation of this product, please install it in a clean, dry, ventilated place, and ensure that the ground contacted by this product is flat and firm.

2. Space requirements

In order to ensure that this product does not touch any objects within the working range, the installation space must meet the following requirements:

- a) The length is not less than 4000mm
- b) The width is not less than 2600mm
- c) The height is not less than 2000m;

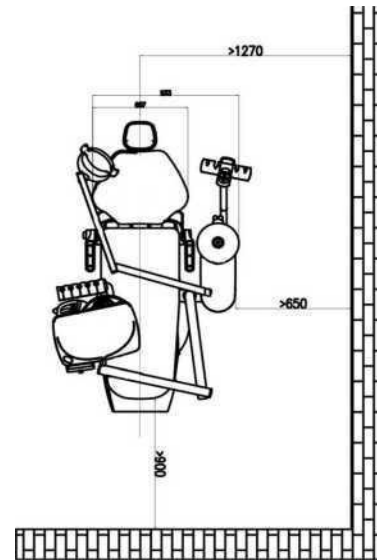

II. Product Installation

1. Install the handling

Unpack the product, take out the power cord of this product and connect the power supply.

Raise the dental chair to the highest position, remove the front and bottom shells, and unplug the power cord.

Use the P43 point hex screws to remove the six screws that fix the patient chair on the bottom of the package, and carefully transport the dental patient chair to the intended installation location.

Take out the six screws from the bottom plate, and carefully transfer the dental patient chair to the given mounting position.

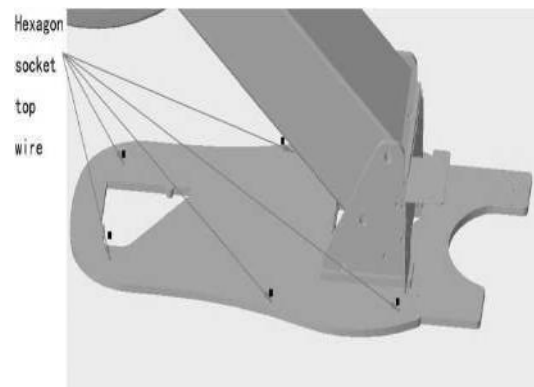

Attention :

During the transportation process, do not lift the fragile parts such as the arm, handrail, assistant's frame, box, plastic shell, etc., as to avoid damage due to excessive handling force!

During the transportation process, please stabilize the tool tray to avoid accidental touch when it is turned left and right!

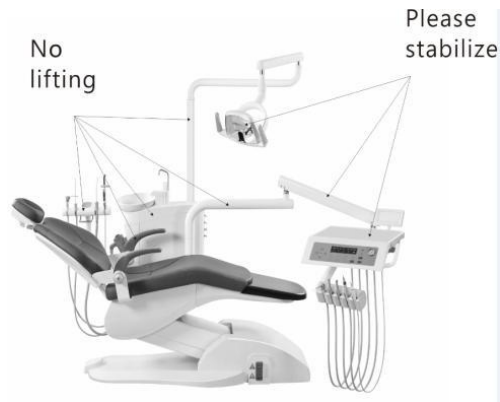

2. The connection between the treatment and patient chair

During lifting the dental unit, make sure the docking port is 10cm away from the patient chair.

The installer puts the pipeline at the interface of the patient chair (the pipeline must be connected according to the number) into the butt joint of the treatment machine, and fixes the treatment machine on the patient chair using the three M10 socket head screws.

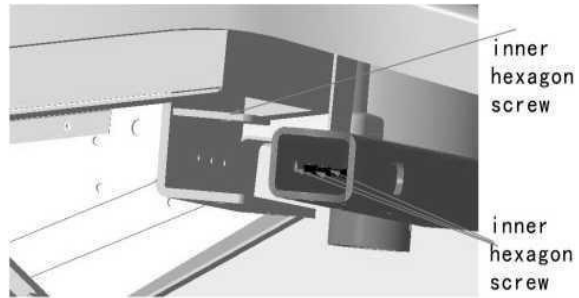

3. Installation of patient chair backrest

Use four pcs M10 inner hex screws to fit the backrest to the patient chair.

Attention:

Prevent sharp object from scratching backrest skin in the installation process!

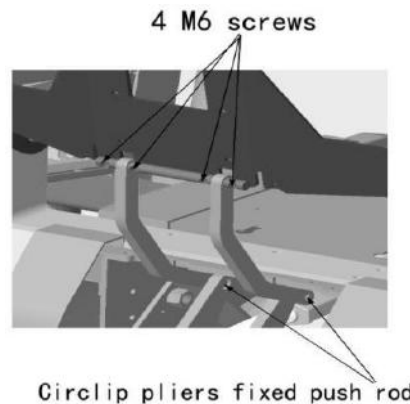

4. Installation of patient chair cushion

Take out the three screws at the bottom of the seat cushion re-screw the seat cushion through the corresponding three holes in the patient chair, and tighten the hex screws.

During the installation process, sharp objects should be avoided to cut the backrest skin.

Attention:

Prevent sharp object from scratching backrest skin in the installation process!

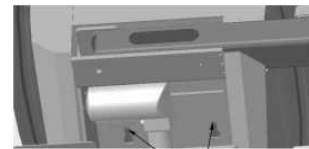

5 M6 inner hexagon screw

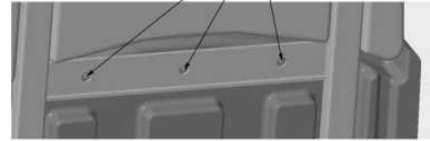

5. Installation of cushion housing

Take out the cushion housing, align it and then take four tapping screws and screw them in the seat cushion base.

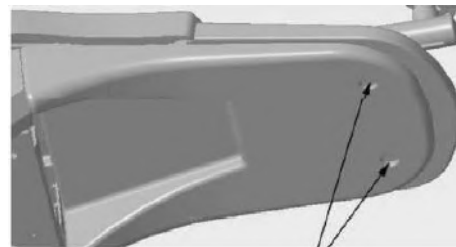

inner hexagon screw

6. Oral LED lamp installation

Open the lamp arm box, as shown in Fig.1, install the lamp arm in sequence.

Take out the oral cold-light lamp and unscrew the M5 inner hex screw from the connecting shaft, as shown in Fig.2; Sleeve the decorative ring out of the lamp arm connecting shaft;

connect the power plugs of the cold-light lamp connecting axle and lamp arm connecting axle;

and plug the power cord and plug into the lamp arm axle, then insert the cold-light lamp connecting axle into the lamp arm axle, and fasten them with attached M5X12 bolts.

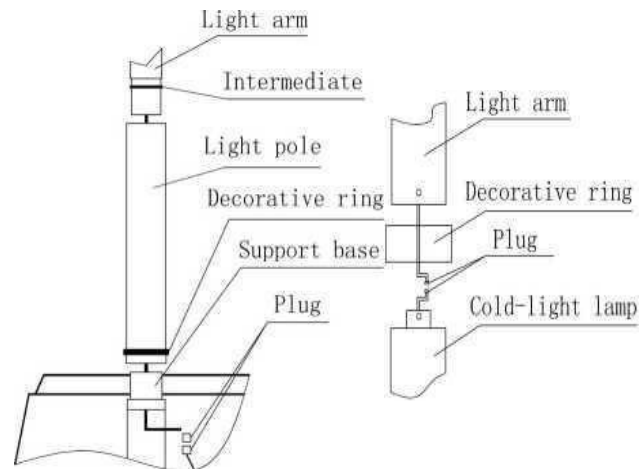

7. Installation of water and air pipes of floor tank

Connect the water and air inlet pipes and drainage pipe of the unit to water and air source and drain port respectively;

In connection, keep the water and air pipe interfaces well sealed to prevent water/ air leak. Connect the earth wire of the unit.

According to the installation position of the unit, lay the water and air inlet pipes and drainage pipe, use (PVC water and air inlet pipes (i.e. ZG1/2");

use drainage pipe with inner dia. Greater than 27.5mm, with drain port retained. See the installation figure at the right.

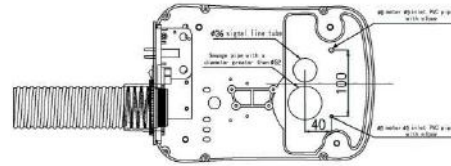
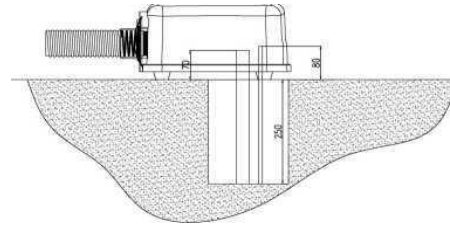

Attention:

1. The drain port height shall not exceed the height of patient chair above the floor, other water inside the drain pipe may flow back!
2. Be sure to lay the drain port in a smooth-flow inclined type.
3. Be attentive not to make the drain pipe twisted, ups or downs, don't put drain port in water.

- ① Φ36—Electrical and communication connection area
- ② Φ52 — Waste pipe
- ③ Φ36—Water supply pipe
- ④ Φ36 —Ccompressed air connection area
- Φ52—Suction tube (vacuum negative pressure)

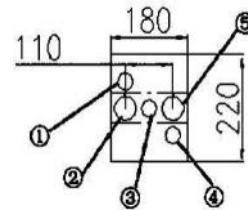

8. Horizontality adjustment of unit

Screw six attached M12 hex screws into six M12 thread holes at the base plate of the patient chair, adjust the screwing length till the horizontality of the unit.

Attention:

In adjustment, ensure the patient chair base plate contact the ground as much as possible so as to ensure the stability of the apparatus!

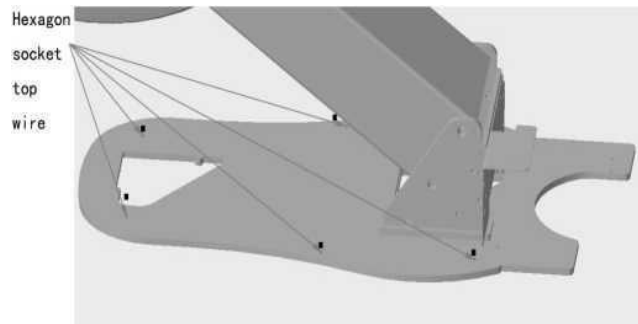

9. Installation of tool tray accessories

a) Installation of 3-way syringe

Take out the nozzle of 3-way syringe from the accessories bag, press down the Convex circle on the gun and insert into the nozzle; then release the ring to make it reset;

if the Convex circle is still at pressed state, indicating it's yet to be positioned; press it again and insert the nozzle deeper till the ring bounces out.

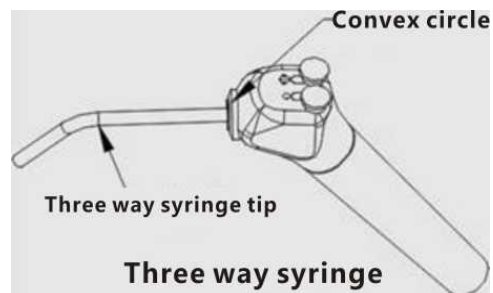

b) Installation of handpiece

Before handpiece installation, turn on the water and air sources, draw out each handpiece hose and step down the foot switch to discharge the water and air residue inside the hoses. In installation, align with the hole positions and screw in the bolts.

Attention:

Refer to the User Manual of handpiece for its use, sterilization and maintenance!

Part 10 Testing

1. The buzzer emits a "beep" sound, the power indicator lights on the tool tray and assistant's stand are on, and the device performs a self-test of the whole machine.
2. Check the water source connection to make sure there is no water leakage at the connection port.
3. Check the air source connection to ensure that there is no air leakage at the connection port.
4. Check the pressure indication value of the air pressure gauge on the air pressure reducing valve. the normal working pressure is 0.55Mpa. If it is wrong, please adjust the adjusting knob of the air filter pressure reducing valve to the above value. The adjustment method is: turn up the knob on the top of the air filter pressure reducing valve, and turn the knob clockwise to increase the pressure value, and vice versa to decrease the pressure value.

Part 11 Operation Instructions

When using the product, please make sure to turn on water, air and electricity!

All setting parameters have the function of automatic saving after power off.

When the power supply is restored after being interrupted, there will be no safety issues except for the temporary interruption of the operation. If you need to continue working, just restart.

1. Instructions for instrument tray button panel

 Seat up key: press the seat up key, the seat up;

 Seat down key: Press the seat down key, the seat down.

 Backrest up key: press the backrest up key, the chair back up;

 Backrest down key: Press the backrest down key, the backrest down.

☆  The preset key: the system presets 3 preset positions with corresponding positions; preset positions can be set manually.

Setting method: first adjust the seat and seat back to the desired position, and then long press the preset. Press the key for about 3 seconds, the buzzer sounds 2 times, and the setting is completed.

During the next operation, short press the preset button, the indicator light is on, and the dental chair will automatically run to the set position. After reaching the position, the dental light will automatically turn on and the indicator light will turn off.

☆  Spittoon key: short press the spittoon position button, the indicator light is on, the seat back moves to the highest position, the seat remains unchanged (if the operating light is on, after pressing the spitting position button, it will automatically turn off); short again Press the spitting position key, and the chair back moves back to the working position. When the chair back reaches the working position, the oral light turns on automatically, and the indicator light turns off.

☆  Oral light: short press the oral light button, the oral light turns on, short press the oral light button again, the oral light turns off.

☆  Reset button: Short press the reset button, the dental chair seat is lowered to the lowest, and the chair back is raised to the highest. If the oral light is turned on before short-pressing the reset button, the oral light will automatically turn off after short-pressing the reset button.

☆  Mouthwash heating: Short press the heating button, the indicator light of the constant temperature water heater starts flashing, the hot water reaches 40 ° C, the water heater suspends work, the indicator light stays on.

when the water temperature drops, the water heater will work automatically, cycle in turn, short press again to heat .Press the key to turn off the water heater and the indicator light is off.

During the movement of the operating chair, the heater is suspended and the indicator light is on.

☆  Spittoon flushing: short press the spittoon flushing button, the indicator light is on, the spittoon starts to flush, after 5 seconds, the spittoon flushing is automatically turned off, the indicator light is off. or short press the spittoon flushing button again to turn off the spittoon flushing.

((Spittoon flushing time setting: The spittoon flushing time system defaults to 5 seconds. You can manually set the spittoon flushing time. The time can be set up to 8 minutes.

Specific method: long press the SET button to set each other for about 3 seconds, the buzzer 2 sounds, the indicator light of the setting key is on, short press the phlegm flush button, the indicator flashes, and the timer starts. Short press the phlegm flush button again, the indicator is off, the timing is over, and the setting is completed.)

☆  Water supply for mouthwash: Short press the water supply button for mouthwash, the indicator light is on, water supply starts, the water supply is automatically turned off after 5 seconds, and the indicator light is off.

Or short press the water supply button again to turn off the water supply.

(Every time after the gargle water supply is automatically completed, the spittoon flushing is linked).

(Gargle water supply time setting: the mouth water supply time system defaults to 5 seconds, and the mouth water supply time can be set manually.

The time can be set up to 8 minutes. Specific method: long press the SET button for about 3 seconds, the buzzer sound 2 sounds, the indicator light of the setting key is on.

short press the mouthwash water supply key, the indicator light flashes, and the timer starts. Short press the mouthwash water supply key again, the indicator light is off, the timer ends, and the setting is completed).

☆ Restore factory settings: Press and hold the oral light button for about 10 seconds, the buzzer sounds twice, the dental chair first drops to the lowest, then rises to the highest, the honey device sounds twice, and the factory settings are restored.

The details include: ① 3 preset positions are restored to the system's default position; ② gargle flood time and phlegm flushing time are restored to the system default time.

☆  Emergency position: The chair frame rises to the highest level and the backrest is flat, and the backrest is placed at -5. , The oral light turns on automatically.

☆  Doctor choose: There are three doctor key positions (A, B, C) for selection. The doctor selects and sets the chair position according to the situation.

2. Instructions for assistant tray.

No.1, 2, 3, 4: patient chair position

No.5: Mouthwash supply

No.6: Spittoon flushing

No.7: Thermostatic water heater

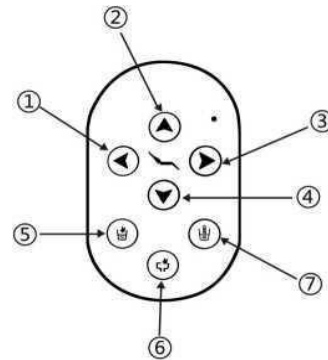

For the function of each key, please refer to the "Instructions for the use of the tool board key board" on page 10.

3. Instructions for water bottle

Configuration 1: Single bottle

The water in the water bottle is only used for instruments on the tool tray. When you choose to use the water storage tank for water supply, follow the steps below:

Step 1: Press the switch "①" to cut off the tap water supply.

Step 2: Turn the switch "②" to "ON", the water source used by the instrument on the tool tray has been converted to the water storage tank for water supply.

Note:

When using tap water to supply water to instruments on the tool tray, make sure that the switch "1" is in the up position! When the switch "2" is turned from "on" to "off", there will be exhaust phenomenon, which is normal!

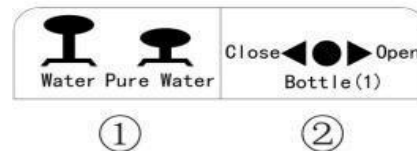

Configuration 2: Double bottles

The water in the water storage tank is only for the instruments on the tool tray.

When you choose to use the water storage tank for water supply, follow the steps below:

Step 1: Press the switch "①" to cut off the water supply.

Step 2: Set the switch "②" to the water bottle you need to use

If water bottle 1 is selected in step 2, please turn on the switch of ③ (water bottle 1), and ④ (water bottle 2) is off. At this time, the water source used by the instrument on the tool tray has been converted to the water storage tank (1).

If water bottle 2 is selected in step 2, please turn off the switch of ③ (water bottle 1), and turn on the switch of ④ (water bottle 2). At this time, the water source used by the instrument on the tool tray has been converted to the water storage tank (2) for water supply.

Attention:

When using tap water to supply water to the instruments on the tool tray, make sure that the switch "1" is in the pulled up position, and turn off the ③ and ④ switches.

When the switches ③ and ④ are switched from "on" to "off", there will be exhaust phenomenon, which is normal

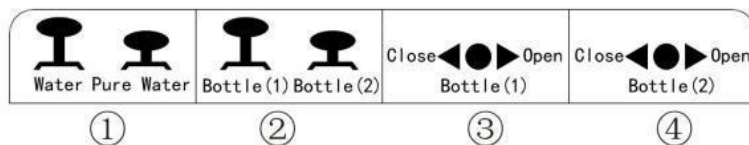

4. Instructions for foot controller

Patient chair position

Push the ball rod to the indicated four directions, and patient chair will move as the icon indication; release the ball rod, it resets automatically and stops patient movement.

- " UP " indicates patient chair rise;
- "DO" indicates patient chair drop;
- " BD " indicates patient chair backrest backward;
- " BU indicates patient chair backrest frontward.

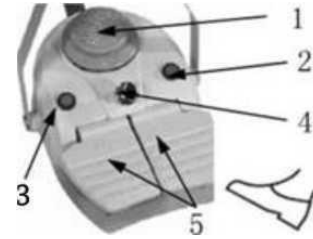

Gargle water supply (SUPPLY)

Press the key lightly, the water supply of the mouth water supply will stop when the water reaches the set time; if during the water supply, press the key again to stop water supply.

Spittoon flushing (RUSH)

Press the button lightly, the bowl will stop flushing for three minutes; during the flushing, if you press the button again, the water supply will stop.

Blowing key (BLOW)

After the work of handpiece, please press this key to dry the residual moisture in the handpiece pipe.

Note:

Please adjust the chip air volume according to your needs! (Refer to "User's Manual for Water and Air Volume Adjustment")

Handpiece work pedal

The left pedal "W" represents the handpiece working water source control switch, and the right pedal "A" represents the handpiece working air source control switch.

The method of use is: when the left pedal is pressed only, the handpiece only works with water; when the right pedal is pressed only, the handpiece works only with air;

When the left and right pedals are pressed at the same time, the water and air sources of the handpiece work at the same time.

Note:

Do not pull out two or three handpiece at the same time!

The handpiece holder has an automatic working lock device. If you need to use your handpiece to work, please pull the handpiece out of the holder!

5. Instructions for water and air regulation of handpiece

Handpiece air adjustment symbol is given in Fig.1, and handpiece water adjustment symbol is given in Fig.2.

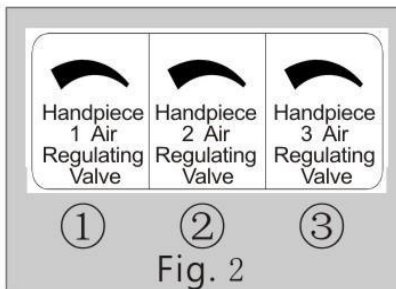
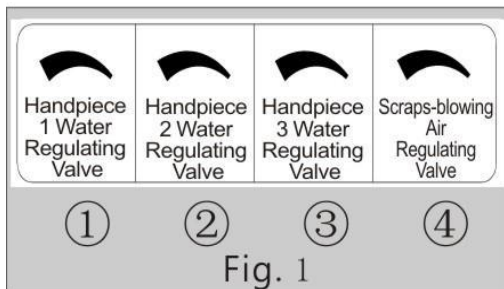

- a) "Figure 1" ②, ③, ④ and "Figure 2" correspond to the adjustment of "Figure 3" ①, ②, ③ handpiece Working water volume.

The adjustment method is: connect three handpiece, as shown in the figure, pull out any handpiece At the same time, step down the two pedals of the foot controller, and press the corresponding knobs of

"Figure 1" and "Figure 2" to rotate the adjustment, The volume of gas.

The air volume is observed by the handpiece barometer on the tool tray, and the water volume is observed by sight.

- b) "Picture 1" ① Adjust the blowing air volume of the handpiece. Adjust the air volume and turn the knob
 c) according to the indication.

Note: Do not pull out two or three handpiece at the same time!

6. Instructions for use of cold light

Cold light should be marked as the right picture:

- ① Strong light.
- ② The light is off.
- ③ Low light. note:

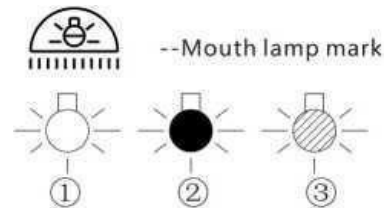

The power of the cold light lamp is controlled by the button of the tool tray!

7. Instructions for using film viewer

As shown in the figure, turn the switch on the side of the film viewing lamp to "ON" to turn on the light, and to "OFF" to turn off the light

Note:

The power of the film viewer can be controlled by the button on the tool tray!

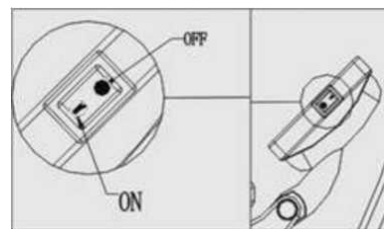

8. Instructions for use of three way syringes and saliva suction system

- ① Three way syringes

Press the " " button to spray water;

Press the " " button to spray air;

Press " " and " " spray atomizing.

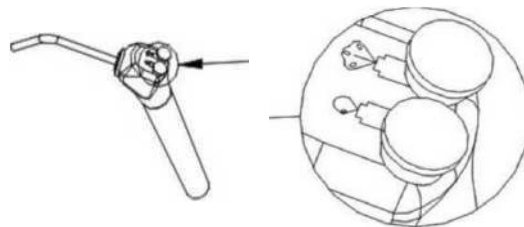

②Saliva suction device

Remove the strong and weak suction heads from the assistant's holder respectively, they will automatic suction work

Part 12 Maintenance

1. To keep the product clean, use medical alcohol to wipe the surface of the cleaning product daily.

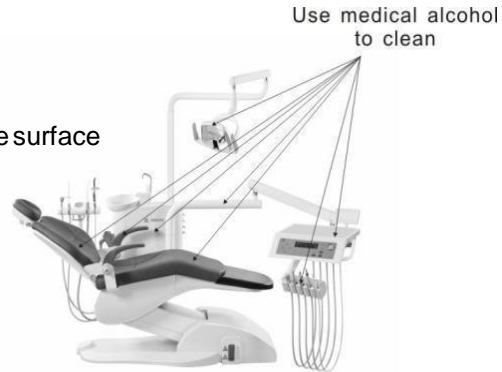

2. In order to maintain the good condition of the moving parts of the product, lubricating oil should be added to the rotating parts regularly, it is recommended to be at least once a year.

3. In order to keep the tap water clean, the filter element of the water filter in the floor box, should be cleaned regularly with a neutral detergent (the filter element specification is less than 5 days plus), it is recommended to be at least once every 6 months.

If you find any damage to the water filter housing or filter element, replace it immediately.

4. In order to keep the water in the water storage tank clean, the interior of the water storage tank should be cleaned regularly with a neutral detergent. It is recommended to use it at least once a week. Before disassembling the water storage tank, please disconnect the air source switch of the water storage tank.

5. In order to keep the gas used dry, the water accumulated in the air pressure reducing valve (the filter element specification is less than 50%) in the floor tank should be discharged regularly, and it is recommended to be once a week. If air leakage is found in the air pressure reducing valve, it should be replaced immediately.

6. The maintenance of the oral lamp should be carried out at normal temperature, and the surface can be wiped with a damp soft cloth. The reflective surface can only be cleaned with compressed air.

7. After the suction filter is easy to accumulate solid dirt, it should be removed regularly and cleaned with clean water. It is recommended to clean it before work every day.

8. Please refer to the instruction manual of the mobile phone for maintenance and disinfection before use.

Part 13 Common faults

Fault phenomenon	Reasons Analysis	Troubleshooting	Remark
Operation light is not on	<ol style="list-style-type: none"> 1. The bulb burns out 2. Poor lamp contact 3. Poor connection of the connector 4. The fuse on the secondary side of the power transformer burns out 5. Twisted wires inside the movable joint 	<ol style="list-style-type: none"> 1. Change the bulb of the same model 2. Insert after correcting with a tool 3. Replace the fuse of the same model 4. Swap the new line 	
Mouthwash water supply cannot be turned off	<ol style="list-style-type: none"> 1. There is a foreign body stuck in the spool of the solenoid valve 	<ol style="list-style-type: none"> 1. Dismantle and wash the valve core 	
Gargle water supply without water	<ol style="list-style-type: none"> 1. Distorted and collapsed water pipes 2. The solenoid coil is burnt out 	<ol style="list-style-type: none"> 1. Arrange or replace the new tube 2. Replace with a new solenoid valve 	
Mouthwash temperature is too high	<ol style="list-style-type: none"> 1. A temperature relay in the upper cover of the water heater fails 2. The temperature of the thermostat is too high 	<ol style="list-style-type: none"> 1. Replace with a new water heater 2. Re-adjust the temperature 	
The flushing hole is not well drained	<ol style="list-style-type: none"> 1. Blockage of pipeline dirt 2. Plastic tube collapse 	<ol style="list-style-type: none"> 1. Remove dirt 2. Remove and restore it by soaking in hot water, or replace with a new tube 	
No water in the cup	<ol style="list-style-type: none"> 1. Distorted and collapsed water pipes 2. The solenoid coil is burnt out 	<ol style="list-style-type: none"> 1. Arrange or replace the new tube 2. Replace with a new solenoid valve 	
Poor absorption of salivary	<ol style="list-style-type: none"> 1. Dirt blockage inside the pipe 2. The dirt in the filter is blocked 	<ol style="list-style-type: none"> 1. Clean with clean water or remove with clean water 2. Remove the filter and clean it 	

Part 14 Circuit Diagram

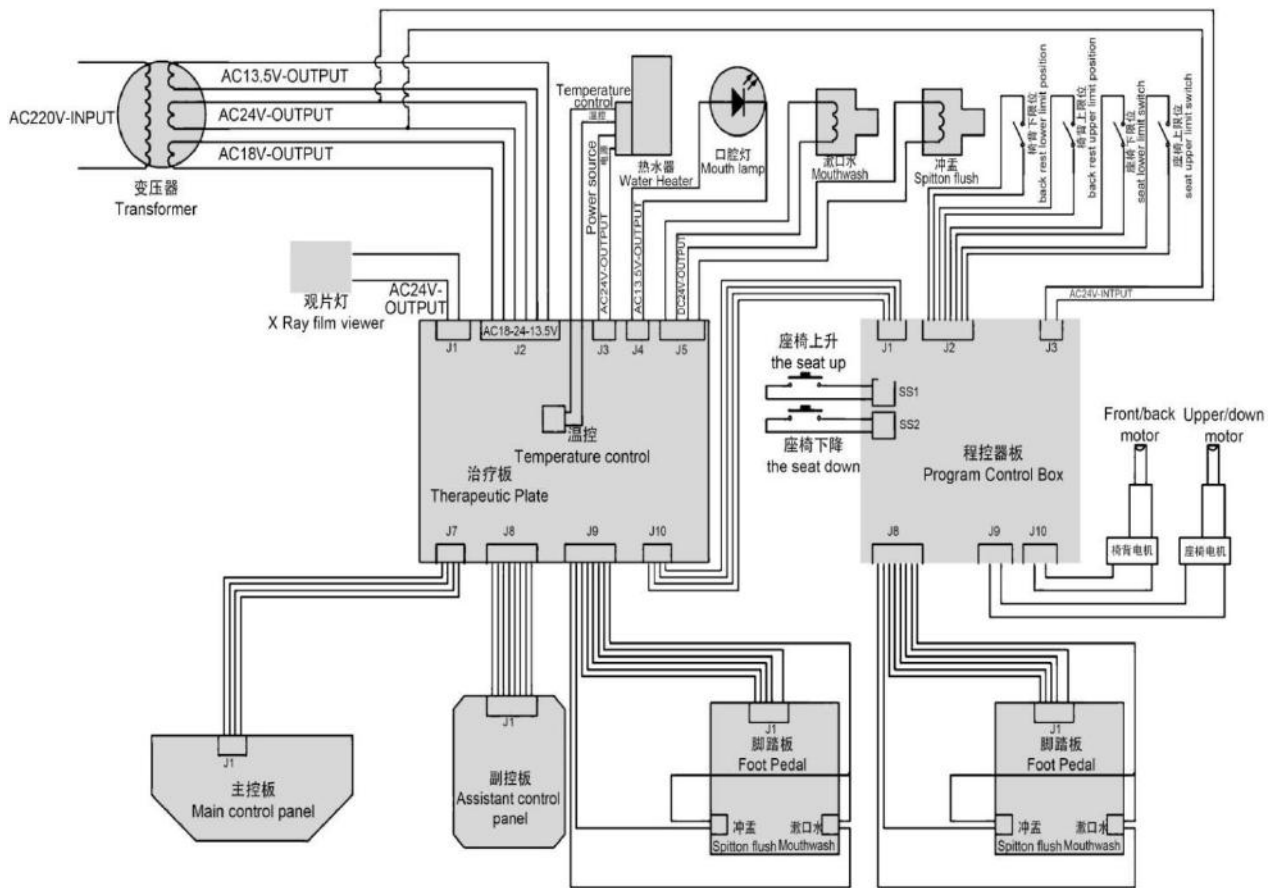

Part 15 Circuit Diagram of Patient Chair

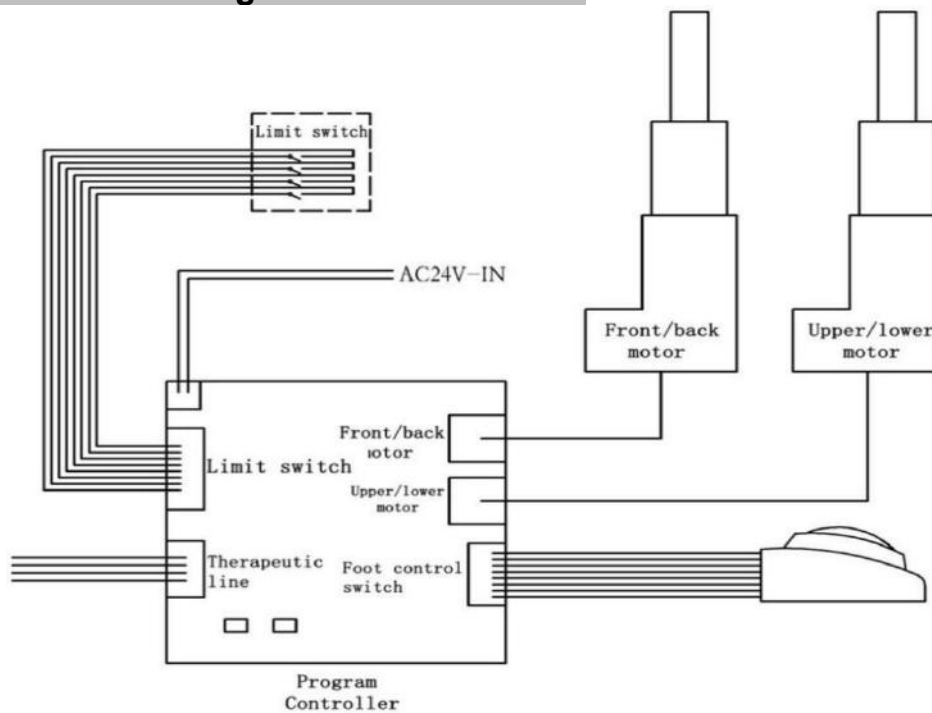

Part 16 Water and Air Installation Diagram

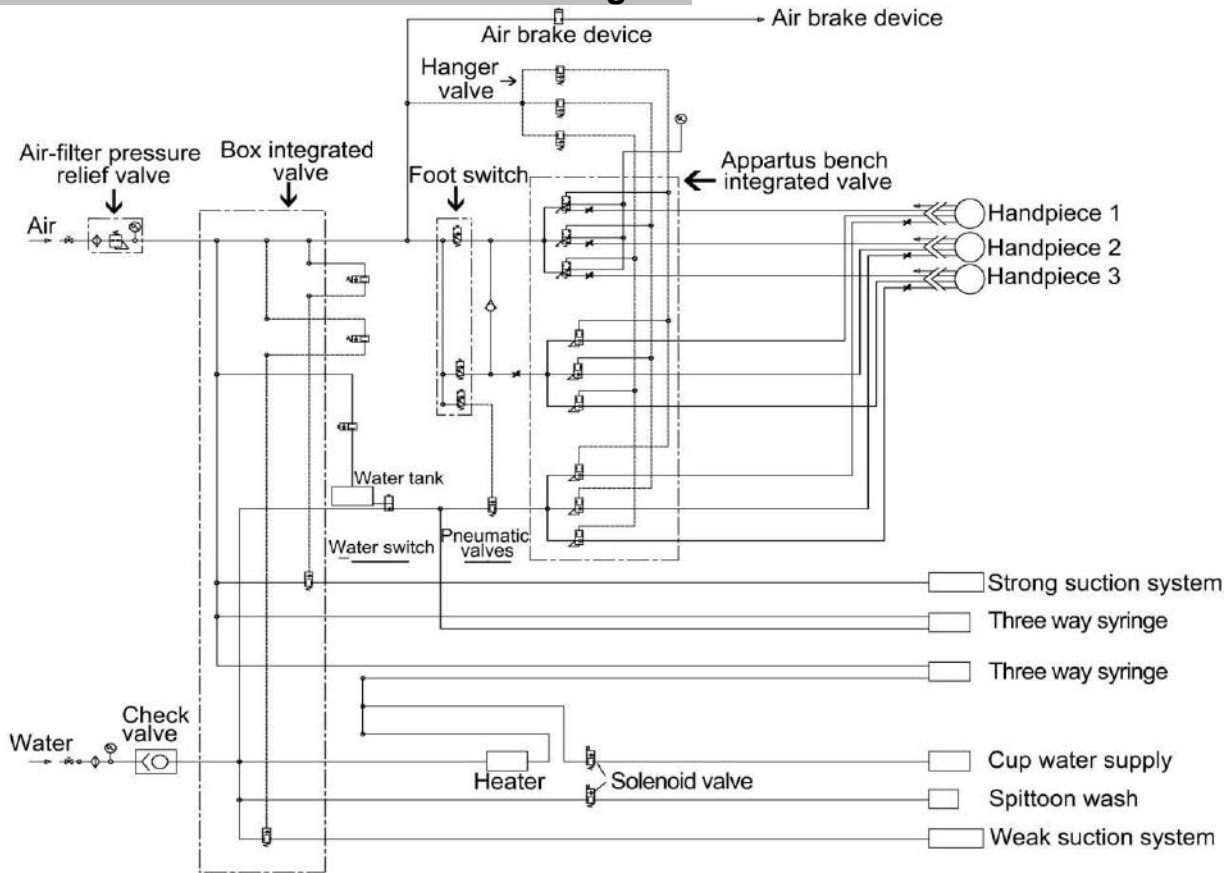

Part 17 Schematic Diagram for Water and Air Routes

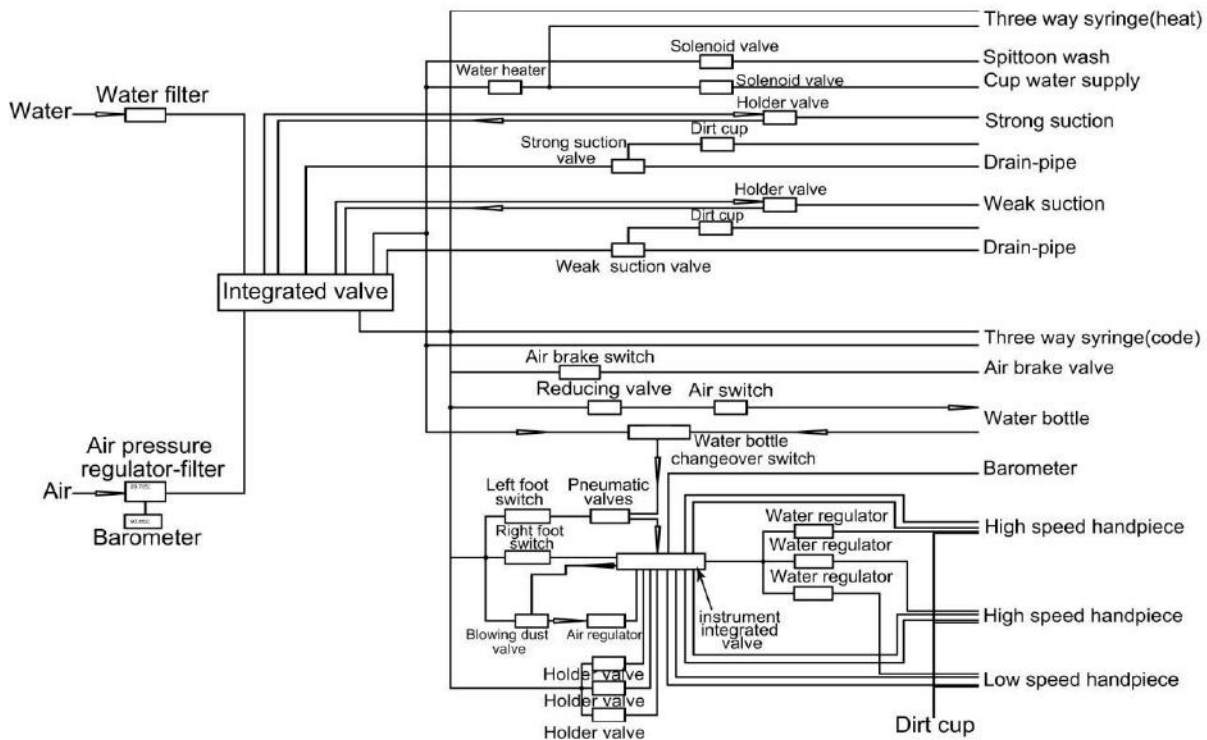

Note: Water pressure of the above water and air elements shall not exceed 0.4PSd, and air pressure shall not exceed 0.8MPa

